

**NA4905-XL**

Needle roller bearing

Schaeffler ID:
0506595880000

Needle roller bearing NA49..-XL, single row, with inner ring, outer ring with 2 bords

X-life

Technical information

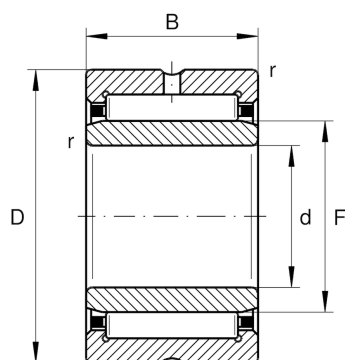
**Main Dimensions & Performance Data**

d	25 mm	Bore diameter
D	42 mm	Outside diameter
B	17 mm	Width
C_r	26,500 N	Basic dynamic load rating, radial
C_{0r}	31,500 N	Basic static load rating, radial
C_{ur}	5,800 N	Fatigue load limit, radial
n_G	14,400 1/min	Limiting speed
n_{gr}	7,700 1/min	Reference speed
	0.09 kg	Weight

Dimensions

F	30 mm	Raceway diameter inner ring
r_{min}	0.3 mm	Minimum chamfer dimension
s	0.8 mm	Axial displacement

Temperature range

T_{min}	-30 °C	Operating temperature min.
T_{max}	120 °C	Operating temperature max.